

# Rooftop Products

ReRoof Drains  
Flashings for All Systems  
New Construction Drains  
Expansion Joint Covers  
PedestalPlus  
Equipment Rails  
Roof Curbs



## ABOUT PORTALS PLUS

Since 1977, the Portals Plus line of products by Hart & Cooley, Inc. has been a leader in the roofing industry. We are committed to providing you the best possible products and services for all of your roofing needs. Portals Plus products offer solutions for roof leak challenges encountered by architects and building owners. 85% of all roof leaks occur at penetrations and corners due to poor details which fail to accommodate architectural movement. Field fabricated flashings may help create temporary solutions but often at the building owner's ongoing expense. Portals Plus products are permanent solutions to your roofing needs.



# TABLE OF CONTENTS

- Solutions For Leak Problems ..... 4
- Retrofit Flashings..... 5
- Shingle Flashing Systems ..... 6
- Deck-Mates ..... 7
- Pipe Flashings ..... 8
- Alumi-Flash Systems..... 9
- Pipe Portal Systems ..... 10
- 5-Hole Pipe Portal Flashing System.....11
- Double Pipe Portal Systems..... 12
- Equipment Rails ..... 13
- Pipe Mounting Pedestals..... 14
- PedestalPlus..... 15
- Roof Drains..... 16
- Overflow Drains & Drain Options..... 17
- Parapet/Scupper Drain ..... 18
- ReRoof Drains ..... 19-21
- Premolded Corners ..... 22
- Vents & Breathers..... 23
- Expansion Joint Covers..... 24-25
- Tapes & Adhesives ..... 26
- Standard Product Warranty ..... 27

## SOLUTIONS FOR ROOF LEAK PROBLEMS

*For all types of roofs*

Good roofing practice allows penetration movement independent of the roof. This requires a flexible seal at the penetration and proper attachment to the roof. With the complexity and assortment of roofing systems available today, a variety of designs are required to work with all conditions. A good flashing system must be versatile / economical / maintenance free / simple to

install / adapt to multiple penetrations and angle irons, yet have uniformity allowing fast, easy installation and specification. All components must be weather resistant, approved by the industry and, above all, eliminate leaks. For these reasons, the Portals Plus product line offers the following products.

### Sources of Trouble

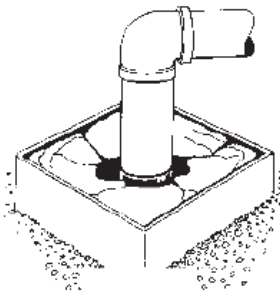

Pitch Pocket

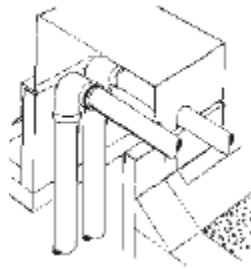

Field Fabricated Hood

#### Disadvantages

- Very costly
- Pipe projection not sealed
- Limited pipe direction
- Does not allow for movement
- Temporary seal
- Continual maintenance
- Major cause of roof damage

### Realistic Answers

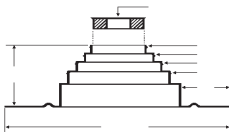

Retrofit Flashing

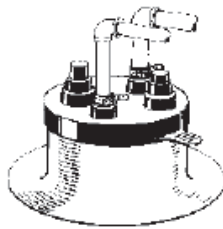

Alumi-Flash

#### Advantages

- Allows penetration movement
- Maintenance free
- Economical and uniform
- Accommodates multiple projections
- No need to disconnect lines
- Eliminates leaks
- Permanent
- Simple and fast to install

Roof leaks are the biggest problem of architects and building owners. Extreme roof temperature changes require durable and flexible flashings. The National Roofing Contractors Association states: "Pitch pockets or pans by their design, are not intended to be continuously watertight. Their use should not be encouraged since

better methods are available to accomplish the same end. Pitch pans or pockets require frequent inspection and maintenance, and usually a great deal of damage can occur before the leak around a pitch pan or pocket is evident."

# RETROFIT FLASHINGS

*For existing penetrations that can not be disconnected*

The Retrofit Flashing offers a quick and easy installation, eliminating roof leaks at pipes and other roof penetrations without disconnecting the penetration. However, the Retrofit still allows for movement between the penetration and roof, while maintaining a perfect seal. The perfect seal is achieved with an integral tongue and groove closure, plus an overlapping flap, and is mechanically fastened with stainless steel hardware, which is included. Retrofit Flashings are available in EPDM (Ethylene Propylene Diene Monomer) for single-ply roofing and

Neoprene for built-up asphalt, coal tar pitch, modified bitumen and cold process systems. Both materials have excellent resistance to ozone and ultraviolet degradation and a serviceable temperature range of -60° F to +270° F. There are two Retrofits available: Small, for pipes 1" to 3", and Large for pipes 3.5" through 6". The Retrofit Flashings also have the added benefit of a variety of adapter rings allowing for even greater versatility. By using the Retrofit Adapter Rings, projections with unusual shapes can be flashed in a positive and secure manner.

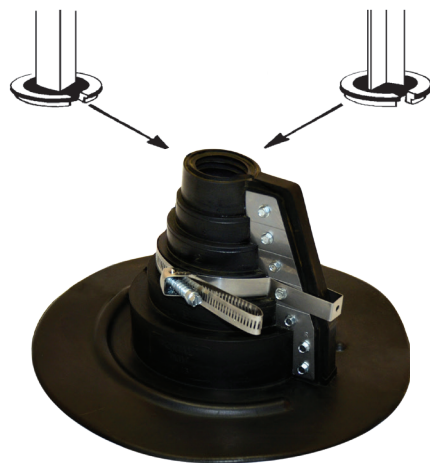

U.S. PAT. 4211423 CAN. PAT. 1-129909

### Adapters available



**Angle Iron**  
1.00", 1.75", 3", 4"



**Square Tube**  
3" and 4"

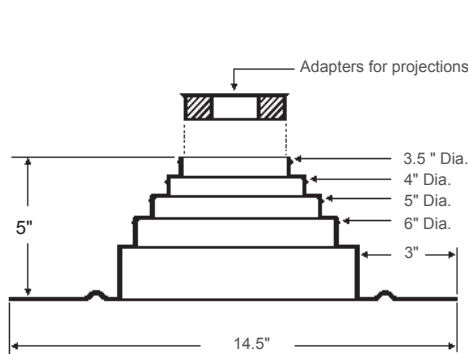

Large Retrofit

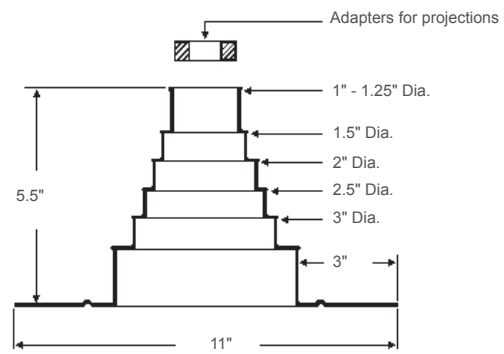

Small Retrofit

## SHINGLE FLASHING SYSTEMS

*Flashings for all types of shingle roofs*

Portals Plus Shingle Flashings are designed to effectively seal round pipe penetrations, from 1.25" through 4", at up to 40° slopes. The seal is an elastomeric collar integrally locked into a rigid base which remains flat on the roof. Bases are available in 24 gauge galvanized steel, .032 mill finish aluminum and black thermoplastic. Installation is easy, the Shingle Flashing slips over the pipe and automatically seals to the pipe at the correct roof angle. Pipes can be all types, including copper, cast iron, plastic,

aluminum and galvanized. Shingle Flashings are rated to 180° F continuous heat and are also available in an all elastomeric one piece Shingle Flashing usable to 45° slope and 200° F continuous heat. All Portals Plus Shingle Flashings are listed by UPC, SBC and BOCA, the three major national codes. Shingle Flashings are available to fit the following nominal pipe sizes: 1.25" - 1.5", 2", 3" and 4".

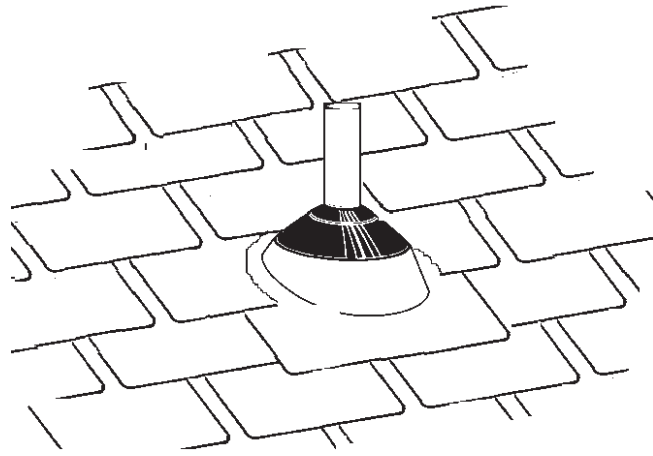
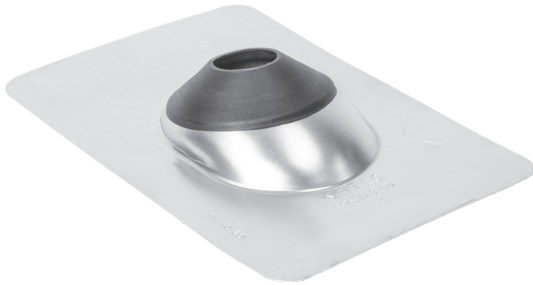

Galvanized



Thermoplastic



Aluminum

# DECK-MATES

Flashings for metal roof and wall systems

The Deck-Mate flashing incorporates a stepped profile which creates a compression seal between the schedule 40 piping and the flashing. Deck-Mates are designed with proper reinforcing ribs to allow the flashing to maintain rigidity and the shape of the product. By combining the stepped profile and the reinforcing ribs, the product will properly accommodate the use of a stainless steel clamp. The clamp is crucial in maintaining a water-tight seal for years to come.

All other products on the market incorporate the use of caulk to seal the penetration. The National Roofing Contractor Association states, in their better roofing practices, that caulk should never be used as a primary sealer of a penetration.

The Deck-Mates are designed to accommodate projections from .125"-26" in diameter and work in conjunction with any configuration of corrugated metal roof. The product is engineered to incorporate a dead soft aluminum flange that bends to any contour, roof irregularity or pitch. Deck-mate is available in two styles, the standard for normal penetration, and Retrofit for piping that can not be disconnected. Flashings are also available in two materials, standard EPDM (grey standard), DM3 and DM5 (black, brown, dark blue, dark green, light green, and terra cotta), and high temperature Silicone (terra cotta).

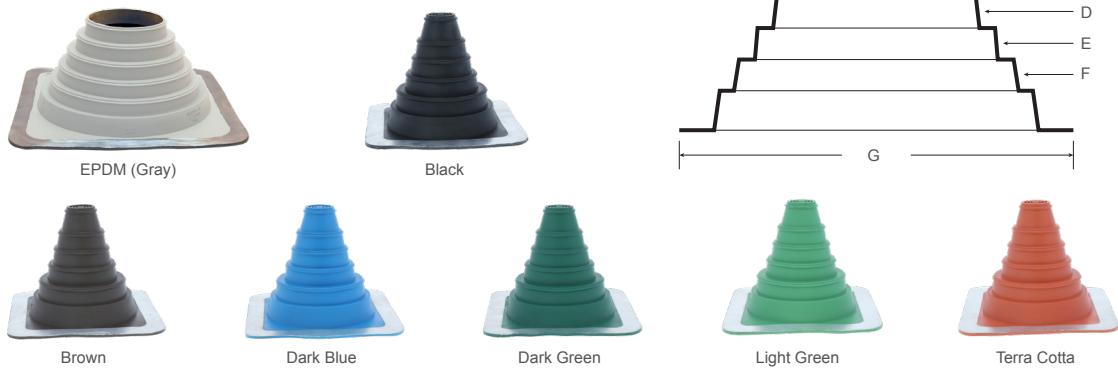

	DM0	DM1	DM2	DM3	DM4	DM5	DM6	DM7	DM8	DM9	DM10
A		0.3		0.5							
		0.8 - 1.0		0.5 - 0.7							
		1.1 - 1.3		0.7 - 1.1							
		0.1 - 0.9		1.1 - 1.3							
B		1.4 - 1.7	1.45 - 1.65	1.3 - 1.65	3.25 - 4.25	4.2 - 5.4	5.4 - 6.4	6.4 - 7.4	7.4 - 8.4	10.5 - 12.5	12.5 x 13.8
C		1.8 - 2.3	2.1 - 2.6	2.1 - 2.6	4.25 - 5.3	5.4 - 6.4	6.4 - 7.4	7.4 - 8.4	8.4 - 9.4	12.5 x 13.8	13.8 x 15.8
D			2.6 - 3.25	3.25 - 4.25	5.3 - 6.4	6.4 - 7.4	7.4 - 8.4	8.4 - 9.4	9.4 - 10.5	13.8 - 15.8	15.8 x 17.8
E					6.4 - 6.9	7.4 - 8.4	8.4 x 9.4	9.4 - 10.5	10.5 - 11.5	15.8 - 17.8	17.8 x 19.8
F								10.5 - 11.5	11.5 - 12.5		19.8 x 25.8
G	2.25 x 2.25	5 x 5	6.25 x 6.25	7.6 x 7.6	9.7 x 9.7	12.3 x 12.3	12.3 x 12.3	17 x 17	18.2 x 18.2	24.8 x 24.8	30.2 x 30.2

All sizes shown are in inches

Furnish and install the Portals Plus Deck-Mate as manufactured by Hart & Cooley, Inc., Grand Rapids, MI, at all points where pipes 26" or less penetrate the metal roof and wall system. The Deck-Mate shall be EPDM or Silicone (high temperature) compression molded rubber. EPDM Deckmates shall have a serviceable temperature

range of -60°F to +270°F, and Silicon Deckmates shall have a serviceable temperature range of -100°F to +500°F, and both shall be resistant to ozone and ultraviolet. Unit shall have 1" wide corrosion resistant flexible aluminum base. The Deck-Mate shall also include Portals Plus' Snaplock Clamp (except DM0).



## PIPE FLASHINGS

*Flashings for all size penetrations for single ply roofs*

The "Pipe Boot" is an economical flashing designed for single pipe penetrations on single ply rubber and thermoplastic roofs. The unit will accommodate virtually all pipe sizes, 1.75" and 2.75" on Small Pipe Boot, 1" through 6" on Medium Pipe Boot and 8" through 12" on Large Pipe Boot. Pipe Boots are available in EPDM, TPO, PVC, or Neoprene material. The Quadraseal is designed to allow as many as four pipes up to 2" in diameter to pass through a single flashing. Quadraseals are available in

EPDM material only. The conically shaped steps of the Portals Plus pipe flashing will securely seal all pipes. The large double thick molded rib at the top of each step offers supreme tear resistance and reinforcement, as well as a built-in cutting guide. Utilizing the Pipe Flashings eliminates the workmanship error in field fabrication and makes flashing pipes clean and consistent.

Adapters for square tube and angle iron are available to fit most pipe boots.

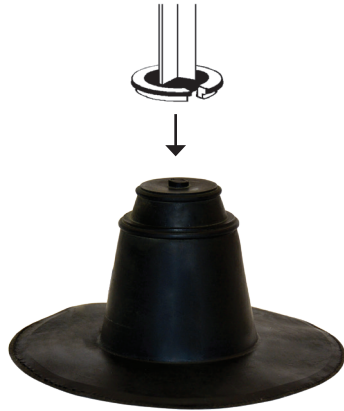

Small Pipe Boot

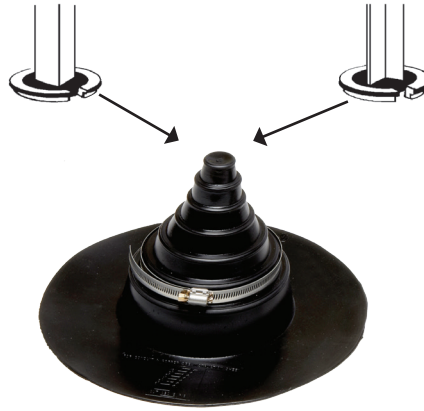

Medium Pipe Boot



Large Pipe Boot



Quadraseal 212R



# ALUMI-FLASH SYSTEMS

*New construction flashings for all roof types*

The Portals Plus Alumi-Flash is compatible with all types of roof systems, making pitch pans obsolete. Due to the flexibility of the EPDM rubber caps, roof leaks are eliminated. Due to this, the penetrations are allowed to expand, contract and vibrate independently of the waterproofing. There are five caps available which can accommodate a variety of pipes, tubes and angle irons from .375" through 12". The caps are molded EPDM rubber which is compounded to resist degradation due to oxidation or exposure to ozone and ultraviolet rays,

while still having a serviceable temperature range of -60° F to +270° F. The caps are mechanically sealed to the Alumi-Flash base with a double "Weather-Tite Pressure Seal," which consists of two beads formed into the collar that mate with the double grooves on the inside of the caps. The base must be roofed in, using skilled roofing practices. Together, the cap and base provide a permanent, watertight and maintenance free means for penetrating roofs.

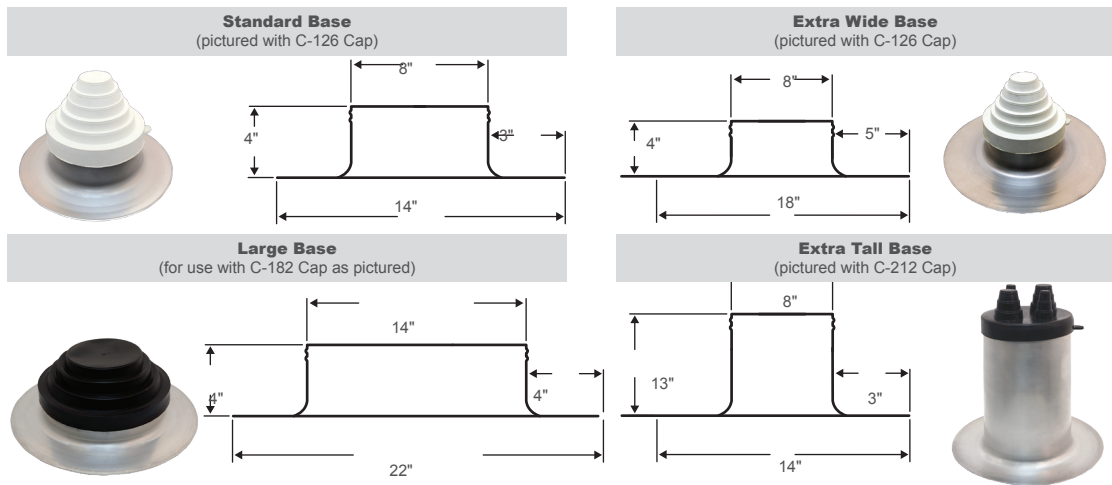

## Select a Cap for Each Base Required

Adapters available to fit most Alumi-Flash



**C-126**  
(1) 2" to 6" Pipe

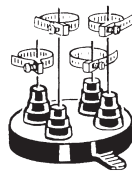

**C-412**  
(4) 1" to 2" Pipes

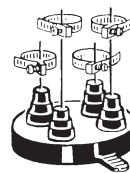

**C-481**  
(4) .375" to 1" Pipes

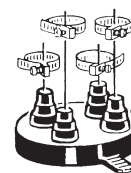

**C-212**  
(2) .375" to 1" Pipes  
(2) 1" to 2" Pipes



**C-182**  
(1) 8" to 12" Pipe



## PIPE PORTAL SYSTEMS

*New construction flashings with roof curb mountings*

A versatile, leak proof and weathertight solution to routing pipes through the roof. The Pipe Portal System is designed to allow for both vertical and horizontal pipe movement, yet provide maintenance free permanent installation, which accommodates pipe sizes of .375" up to 12". The curb cover is molded from ABS (Acrylonitrile Butadiene Styrene) plastic with a laminated acrylic coating, which gives high resistance to both ozone and ultraviolet sun rays, as well as serviceable temperature range of -40° F to + 160° F. The molded sealing rings on the collared opening of the cover, mated with the grooves in the rubber cap, assures a "Weather-Tite Pressure Seal" and mechanical lock.

The protective rubber caps are compression molded of EPDM rubber with a serviceable temperature range of -60° F to + 270° F. They also have high resistance to ozone and ultraviolet sun rays. The conically shaped steps of the cap provide a taut waterproof seal around the pipe, and the Stainless Steel Snaplock Swivel Action clamps provided give the added protection to guarantee the pipe seal. Installation time is reduced almost 75% by the swivel action clamp.



### Adapters available



**Angle Iron**  
1.00", 1.75", 3", 4"



**Square Tube**  
3" and 4"

### Select a Cap for Each Base Required



C-126  
1 - 2" TO 6" Pipe

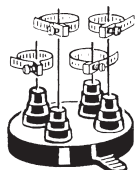

C-412  
4 - 1" TO 2" Pipes

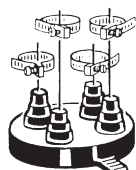

C-481  
4 - .375" TO 1" Pipes

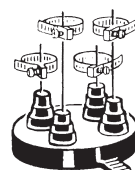

C-212  
2 - .375" TO 1" Pipes  
2 - 1" TO 2" Pipes

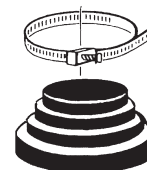

C-182  
1 - 8" TO 12" Pipe

See Page 11 for Standard Curb Styles and dimensions

## 5- HOLE PIPE PORTAL FLASHING SYSTEM

*New construction flashings with roof curb mountings*

Provides pre-manufactured Pipe Portal® flashing systems as manufactured by Duravent Group, Detroit, MI, at all necessary roof penetrations 2-½" or less, or as shown on drawings. Each 5-Hole Pipe Portal flashing system shall include a Portals Plus pre-manufactured roof curb of style as shown on drawings or as specified for roof curbs. Single or double Pipe Portal flashing systems cover with

sealing ribs on each port for a weathertight seal. They feature pre-cut port holes for faster installation and five molded EPDM rubber cap(s) with stainless steel clamps. EPDM rubber shall have a serviceable temperature range of -60°F to +270°F and shall be resistant to the ozone and ultraviolet rays. Use N55 Caps for up to five, ½" to 2-½" pipes.

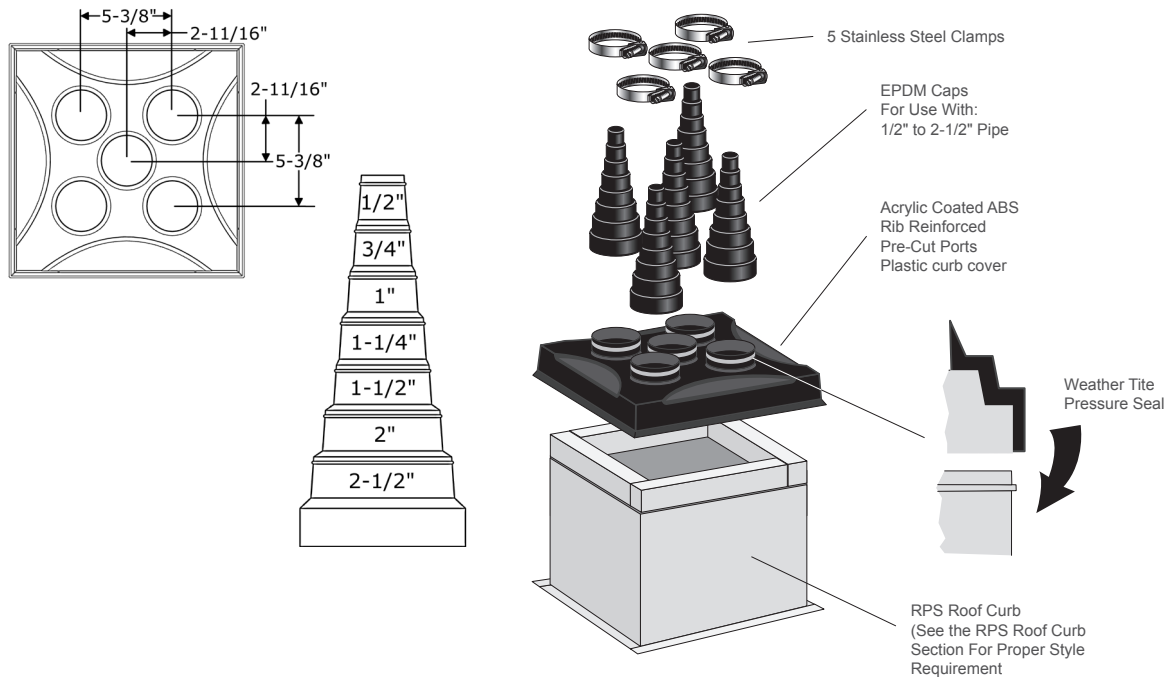

### Standard Curb Styles (Other styles also available)

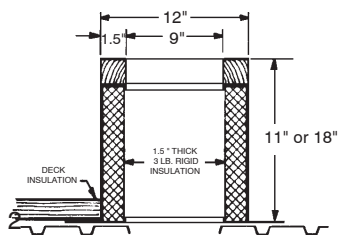

**RC-2A**  
For Decks with Lightweight Fill  
or Tapered Insulation

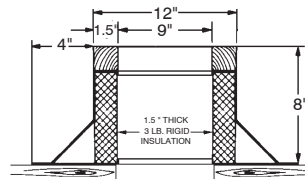

**RC-3A**  
For Noninsulated Decks

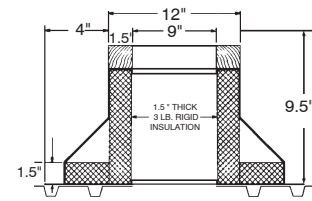

**RC-4A**  
For Decks with  
Rigid Insulation

## DOUBLE PIPE PORTAL SYSTEMS

*New construction flashings with roof curb mountings*

A versatile, leak proof and weathertight solution to routing pipes through the roof. The Double Pipe Portal System is designed to allow for vertical and horizontal pipe movement, yet provide maintenance free permanent installation, which accommodates pipe sizes of .375" up to 6". The curb cover is molded from ABS plastic with a laminated acrylic coating, which gives high resistance to both ozone and ultraviolet sun rays, as well as serviceable temperature range of -40° F to + 160° F. The molded sealing rings on the collared openings of the cover, mated with the grooves in the rubber caps, ensure a "Weather-Tite Pressure Seal" and mechanical lock. The protective rubber caps are compression molded of

EPDM rubber with a serviceable temperature range of -60° F to +270° F. They also have high resistance to both ozone and ultraviolet sun rays. The conically shaped steps of the cap provide a taut waterproof seal around the pipe and the Stainless Steel Snaplock Swivel Action clamps provided give the added protection to guarantee the pipe seal. Installation time is reduced almost 75% by the swivel action clamp.

The Double Pipe Portal is ideally used to bring the line sets to condensing units, ice-makers, chillers, etc. It is also ideal for mounting roof top satellite dishes.

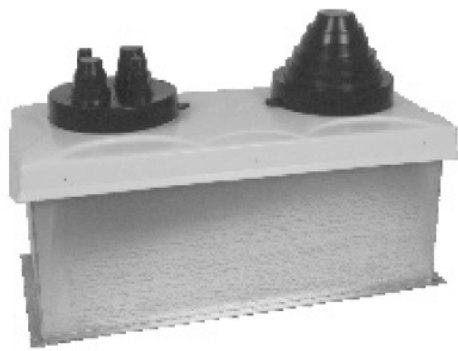

### Adapters available



**Angle Iron**  
1.00", 1.75", 3", 4"



**Square Tube**  
3" and 4"

### Select Two Caps for Each Base Required



C-126  
1 - 2" TO 6" Pipe

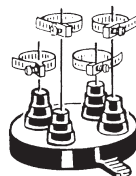

C-412  
4 - 1" TO 2" Pipes

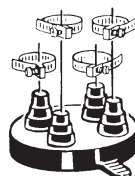

C-481  
4 - .375" TO 1" Pipes

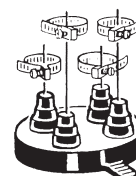

C-212  
2 - .375" TO 1" Pipes  
2 - 1" TO 2" Pipes

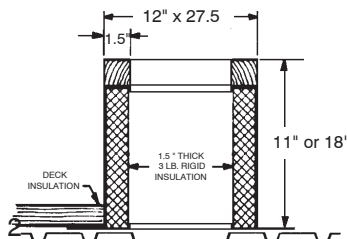

**RC-2A**  
For Decks with Lightweight Fill  
or Tapered Insulation

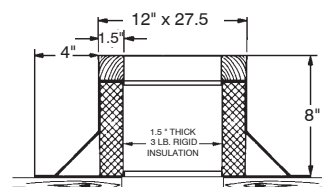

**RC-3A**  
For Noninsulated Decks

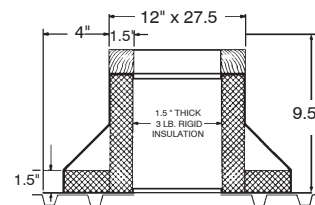

**RC-4A**  
For Decks with  
Rigid Insulation

# EQUIPMENT RAILS

*The solution for mounting roof equipment*

Equipment Rails are prefabricated sheet steel structural members designed for all types of roof systems. They provide a uniform mounting pedestal for condensers, blowers and other roof mounted equipment. Manufactured in 3 ft., 4 ft. and 6 ft. lengths, they are made to match the equipment and to span the proper number of roof joists. These Equipment Rails have a high bearing capacity attained by a system of internal gussets welded

into position at specific intervals along the length of the rails. A continuous wood nailer covered by a removable counterflashing provides for an effective method of attaching roofing felts and assuring a watertight installation. Equipment Rails can replace inadequate railroad ties, arsenic contaminated lumber, costly pipe stubs and leaky pitch pockets.



ER-2A STYLE

## EQUIPMENT RAIL LOADING CHART

STYLE	ER-2A	ER-2A	ER-3A	ER-4A
Width & Height	3.5" x 12"	5.5" x 18"	3.5" x 8"	3.5" x 9.5"
Maximum Allowable Concentrated Load	3000 lbs.	4700 lbs.	1450 lbs.	1800 lbs.
Maximum Allowable End Reaction	3300 lbs.	3800 lbs.	1700 lbs.	2200 lbs.
Maximum Allowable Intermediate Action	3000 lbs.	4700 lbs.	1450 lbs.	1800 lbs.
Maximum Allowable Uniform Load	860 lb./ft.	2300 lbs.	450 lb./ft.	550 lb./ft.

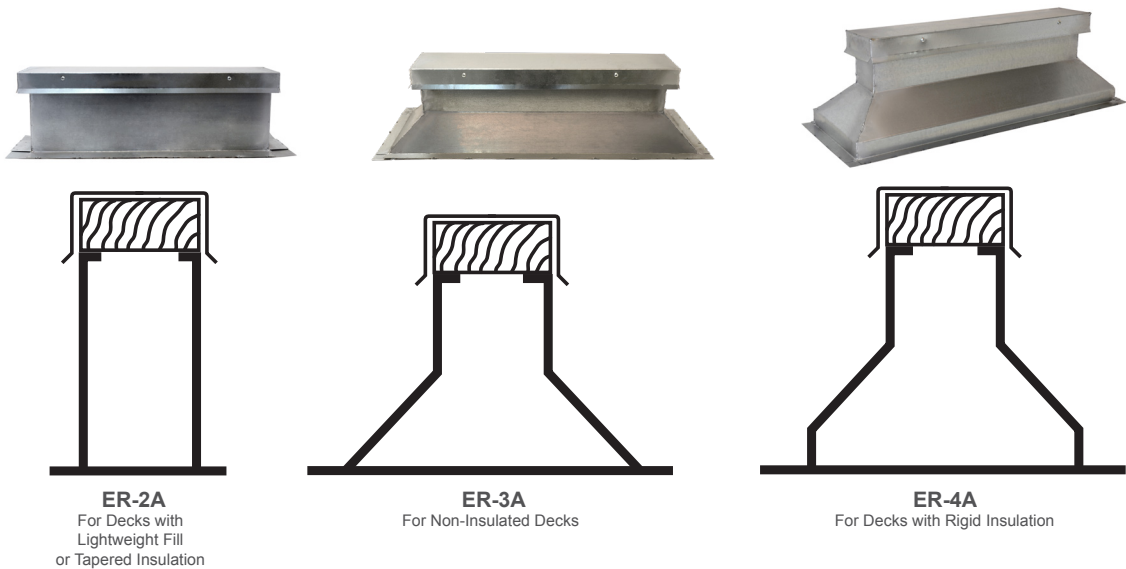

## PIPE MOUNTING PEDESTALS

*The solution for mounting rooftop pipes*

Pipe Mounting Pedestals are the ultimate solution to mounting pipe runs across rooftops and are designed for all types of roof systems. They provide a uniform mounting pedestal for gas pipes, steam lines, refrigerant piping, water pipes, process piping, conduits and other rooftop piping. Using a Portals Plus Equipment Rail as the base unit allows a proper mounting to the roof deck and provides a secure substrate for the roofing assembly flashing system. The pipe roller assembly allows for pipe movement from expansion and contraction, yet still secures the pipe to the assembly to prevent dislodgement. It provides full 12" vertical and horizontal adjustments to allow the piping to be mounted level and straight across the rooftop as well. For weather protection,



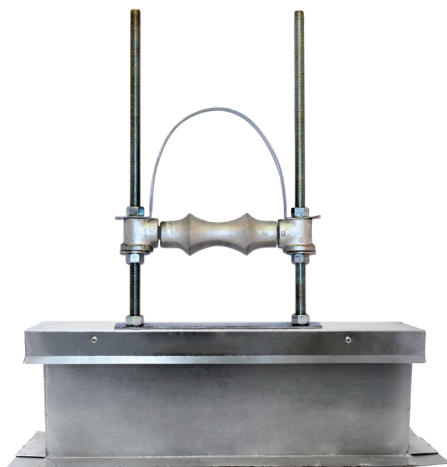

the pipe roller is solid cast iron and all exposed materials are manufactured of weather-resistant galvanized steel. Standard pipe roller assemblies are available for 2", 4" and 6" diameters, with custom sizes available up to 12" diameter. The Equipment Rail is also manufactured of galvanized steel with a wood nailer for securing the flashing assembly. It provides quick and easy installation and allows for future reroofing without disturbing piping and related interior processes. Also replaces inadequate wood blocking, plastic supports and all types of supports that bear directly on the roof system. These supports can compress roof insulation, damage roof membranes and create ponding water conditions that promote the growth of algae that can cause early failure of the roofing system.

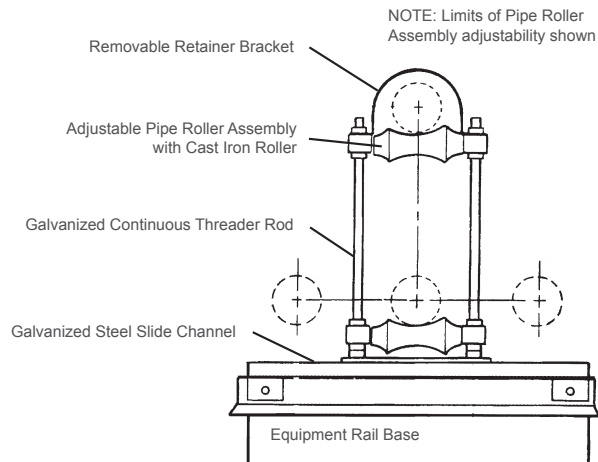

ER-2A Equipment Rail with Pipe Mounting Pedestal

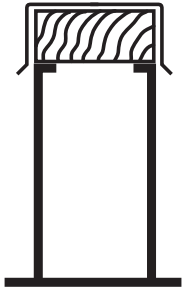
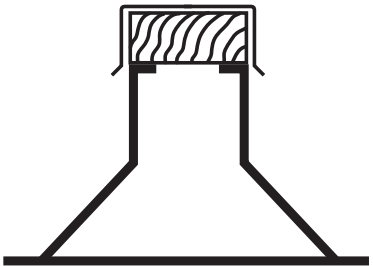

### Select Equipment Rail Base for Each Pipe Mounting Pedestal

		
		
<p><b>ER-2A</b> For Decks with Lightweight Fill or Tapered Insulation</p>	<p><b>ER-3A</b> For Non-Insulated Decks</p>	<p><b>ER-4A</b> For Decks with Rigid Insulation</p>

## PIPE MOUNTING PEDESTALS

*An award winning solution from PortalsPlus*

- White, UV stable, reinforced PVC base
- Made of 25% recycled material
- Qualifies for 3 LEED accreditation points
- Accommodates multiple pipe runs
- Supports loads of up to 150 lbs.
- Quick and easy installation
- A cost effective solution

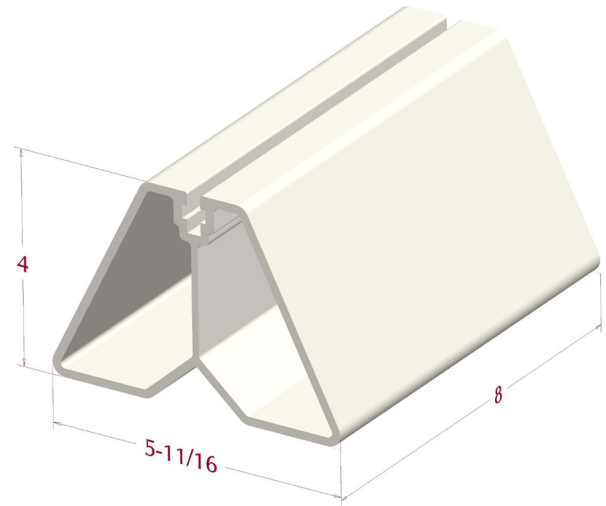

**PedestalPlus**



Pipe Support with U-Channel

Pipe Support with Plumber Strap



# ROOF DRAINS

Roof Drains for new construction

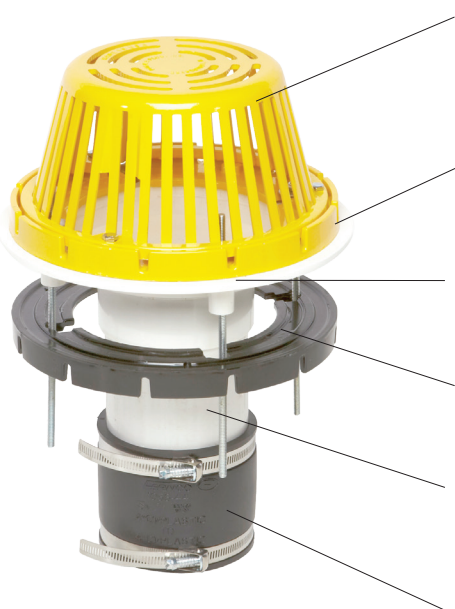

**Dome Strainer\***

Portals Plus Dome Strainer is epoxy coated, die-cast aluminum for longevity. The Dome Strainer bolts securely to clamping collar. (Dome Strainer also available in ultraviolet-stabilized polyethylene)

**Clamping Collar/Gravel Guard\***

Portals Plus die-cast, aluminum, epoxy coated Gravel Guard and Clamping Collar is grooved for positive drainage and ensures a maximum hold on roofing materials.

**Drain Bowl\***

Portals Plus Drain Bowls are available in 3", 4" and 6" sizes in Cast Iron, Cast Aluminum, ultraviolet-stabilized injection molded white PVC and injection molded black ABS.

**Underdeck Clamp\*\***

Portals Plus epoxy coated, cast aluminum underdeck clamp holds the drain bowl securely to the deck.

**Extension\*\***

Portals Plus Extension is a 6" length of schedule 40 pipe that extends the drain bowl down below the deck to accommodate the expansion coupling (for PVC and ABS Plus Packs only).

**Expansion Coupling\*\***

Portals Plus flexible Expansion Coupling allows for expansion and contraction that enables the installer to connect the drain to various types of piping (two stainless steel clamps included).

\*Included in standard roof drain.

\*\* (Plus Pack) Includes standard roof drain and Plus Pack.



PVC Plus Pack



Cast Iron Plus Pack



Cast Iron New Construction Drain



PVC New Construction Drain

**Typical BUR Installation**

**Typical EPDM Installation**

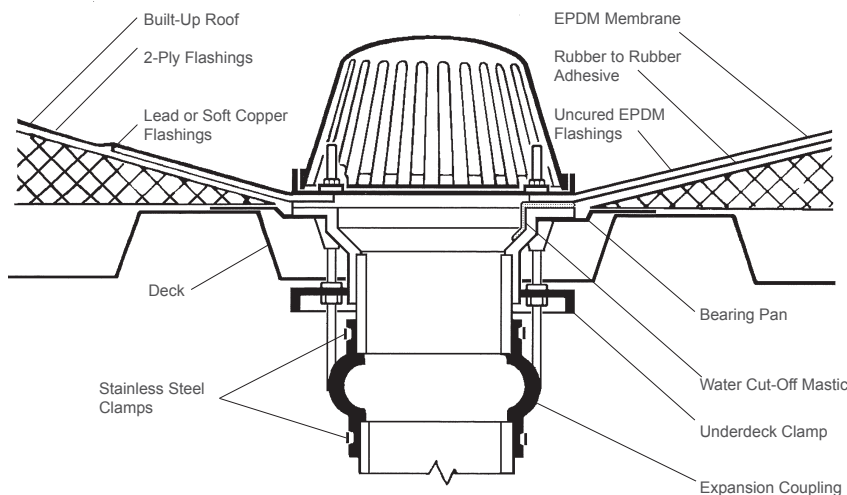

(AS DETAILED IN NRCA MANUAL)

## OVERFLOW DRAINS & DRAIN OPTIONS

*Roof Drains for new construction*

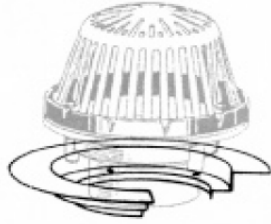

### Extension Pan

For installing a roof drain flush with the top surface of roof deck insulation. Creates an overflow drain when used with an adjacent roof drain installed in a Bearing Pan at the deck surface. Allows insulation to surround the drain and pipe above the deck, preventing any condensation. Simple topside installation of the heavy, 18 gauge spun steel Extension Pan and roof drain. Accepts all Portals Plus Roof Drains and all insulations from ¼" to 5-¼" thick.

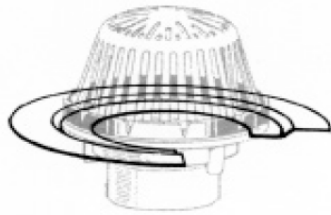

### Bearing Pan

For installing a roof drain flush with the top surface of an uninsulated roof deck. These are often made of materials such as plywood or poured decks. Portals Plus Bearing Pan is made of heavy, 18 gauge spun steel for easy topside installation, and allows structural poured decks to proceed ahead of the plumber (only a standard core hole is required). Accepts all Portals Plus Roof Drains and all roof decks.



### Overflow Clamping Ring

For converting standard roof or reroof drains to an overflow roof drain in order to comply with modern building codes. Simply install this in place of the standard clamping ring. Fits all Portals Plus Roof Drains and ReRoof Drains.

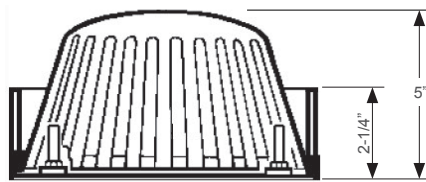

## PARAPET/SCUPPER DRAIN

*Drains for sidewall roof installation*

The Portals Plus Parapet/Scupper Drain is designed for sidewall roof installation to solve those aggravating through-wall drain problems. The Parapet/Scupper Drain combines horizontal and vertical drainage and is made up of four integral parts: the removable angled grate strainer, heavy duty flashing clamp, drain body and the

outlet hub. These outlet hubs may be used at 45° or 90° by removing two bolts and changing the outlet position one-half rotation. The entire Parapet/Scupper Drain is manufactured from powder painted, cast aluminum. (Available in 2", 3" and 4")



Scupper Drain

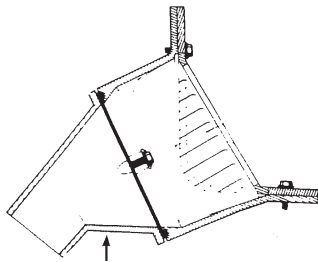
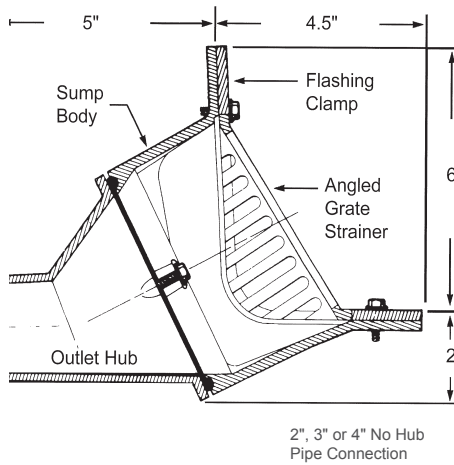

Outlet hub may be used at 45° or 90° by removing two bolts and changing outlet position one half rotation.

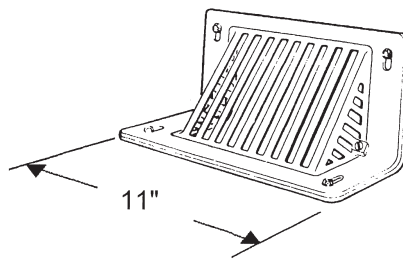

# REROOF DRAINS

*Drain inserts for retrofit applications*

The Portals Plus ReRoof Drain is designed for the easiest and most reliable installation, used in conjunction with an existing drain when reroofing. The unit is based on a flat underside flange for flush roofing material installation. A special pre-compressed, modified asphalt impregnated, expanding foam sealing tape automatically makes a permanent, elastic, watertight seal to the existing drain, eliminating any water back up. The flange and outlet tube are available in aluminum, PVC or high temperature ABS. ReRoof Drains are available to fit 2", 3", 4" and 6" drains.

The drain is completely installed on the roof top with stainless steel hardware and NO special tools. The unit is available with a plastic or cast aluminum dome strainer and an outlet tube that gives minimum downsizing to the existing drain. The Portals Plus ReRoof Drain makes a perfect roofing termination point and offers a total connection to the plumbing below.



Aluminum Insert



Reroof Drain Insert with Dome

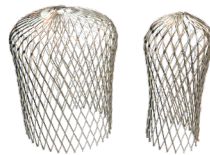

4" Insert Dome | 3" Insert Dome



White PVC



Black ABS



Aluminum

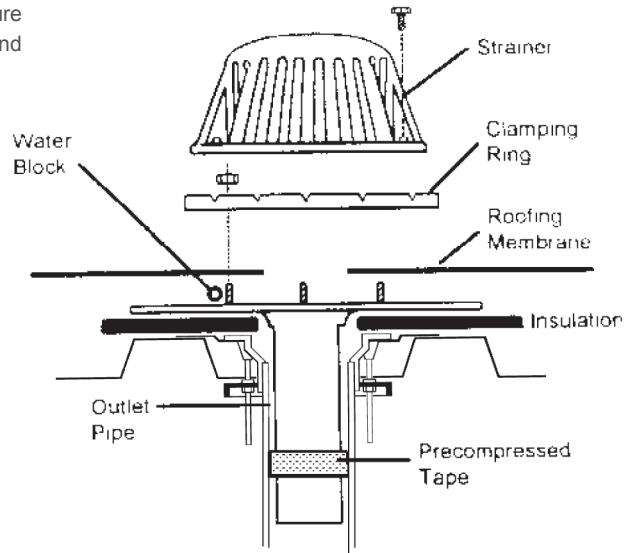

# REROOF DRAINS

*Drain inserts for retrofit applications*

Portals Plus also offers the ReRoof drain with a rubber seal that requires NO TOOLS to activate. The seal is instantaneous as the ReRoof Drain is inserted into the existing pipe. Years of research and testing have resulted in this unique seal that becomes tighter as water pressure increases from backups. Testing done by the engineering firm that designs seals for America's deep-diving nuclear submarines proved that it withstands over a 50-foot

pressure head of water, both with slow increases in pressure and sudden surges from 0 to 50 feet. The seal was found to resist leaking better than cast iron pipe. During the testing, the cast iron pipe developed porosity leakage from the 50-foot pressure head, but the seal held tight. The unique Portals Plus ReRoof Drains are available now in 2", 3", 4", 5" and 6" sizes in your choice of either aluminum or stainless steel.

**SLOW RATE OF PRESSURE INCREASE**

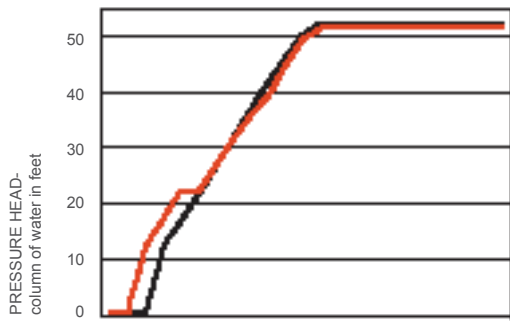

**RESPONSE TO PRESSURE SURGE**

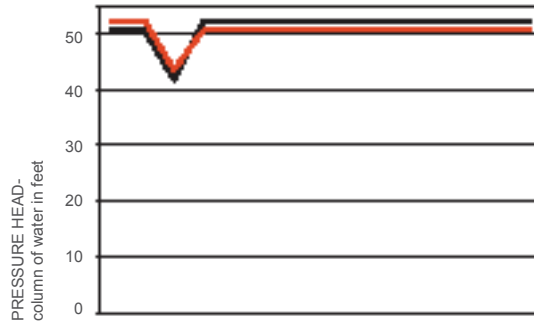

Increased height of water column to 50 feet over one minute- No leakage at seal

Increased height of water column to 50 feet immediately-  
 SURGE: No leakage at seal  
 Held pressure at a 50 feet water column for 18 hours-  
 STATIC: No leakage at seal

- PVC DRAIN PIPE
- CAST IRON DRAIN PIPE

Testing conducted and certified by independent test laboratory



Rubber Seal

Tape Seal

Premier Seal

## REROOF DRAINS

*Drain inserts for retrofit applications*

Portals Plus has developed a unique Mechanically Expandable Rubber Seal for ReRoof Drains, "The Premier Seal." The Drain is designed to replace existing drains in retrofit applications. All installation is conducted on the roof surface. The seal is activated by tightening the internal screws with the Premier Screwdriver. It utilizes PVC flanges for increased strength and stainless steel screws to compress the EPDM rubber gasket.

Compression expands the seal and makes contact into the existing piping of the pre-existing drain, therefore, preventing vertical movement and stopping water damage into the building. The Premier Seal exceeds SPRI and ANSI Retrofit Drain requirements. These unique Portals Plus ReRoof Drains are available now in 3", 4", 5" and 6" sizes in conjunction with the aluminum ReRoof Drain.

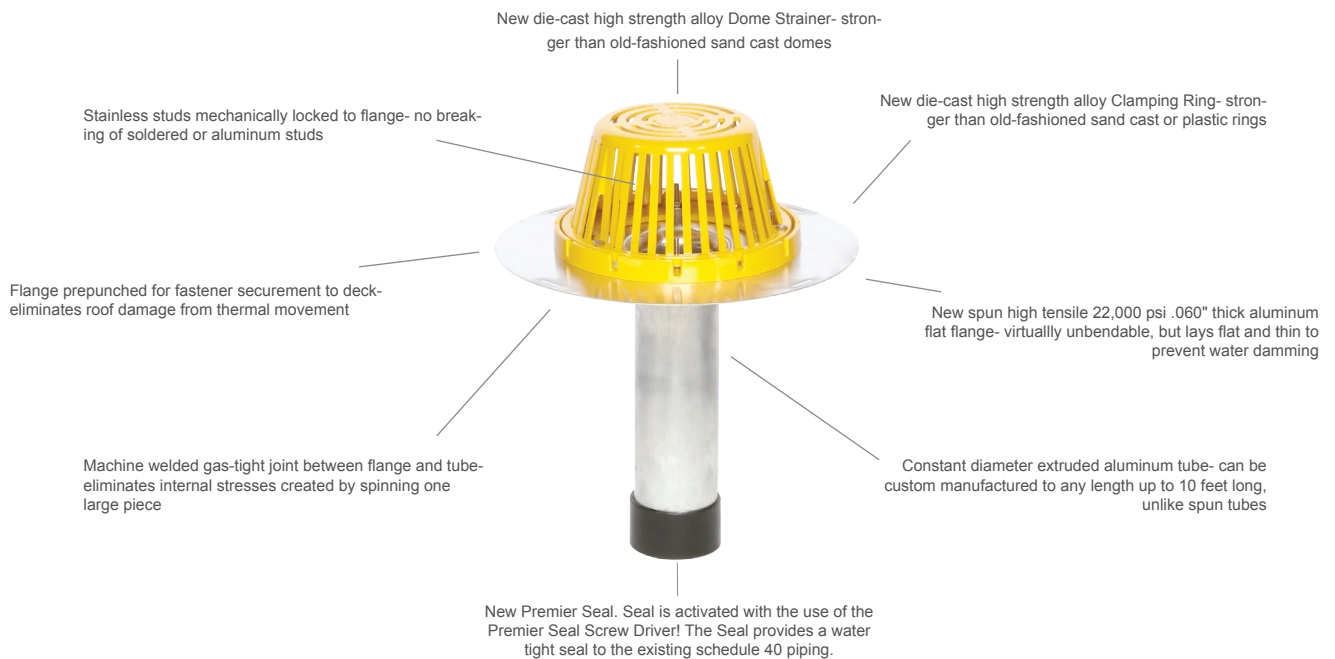

**New die-cast high strength alloy Dome Strainer** means fewer debris-clogged drain lines due to broken domes. Further, the Dome Strainer bolts down to prevent malicious vandalism to the drain system.

**New die-cast high strength alloy Clamping Ring** means secure and even compression of the edge of the roofing system at the lowest point of the roof and prevents backups under the system into the insulation.

**Stainless fasteners** mechanically locked to the flange mean that the Clamping Ring can be truly tightened to seal the membrane without fear of snapping soldered or aluminum studs.

**New spun high tensile 22,000 psi .060" thick aluminum flange** remains flat for flush mounting and eliminates the water dam problem created by a thick flange.

Flange prepunched for easy securement to the deck to control thermal movement and eliminate membrane stresses.

**Machine welded gas-tight joint** between flange and tube creates a unitized construction which eliminates concerns about soldered joints melting and leaking and avoids the internal stresses that cause cracking in large one-piece spinings.

**Constant diameter extruded aluminum tube** means a sure fit and allows cutting at any point with the same diameter. This means that the seal fits the same at any point on the tube and in the drain pipe, unlike spun tubes which taper.

**New Premier Seal!** Utilizes white ABS plastic to ensure better visibility during installation. Mechanical Seal is water-tight!

## PREMOLDED CORNERS

*Pre-manufactured inside & outside corners for all roof systems*

Outside corners provide a guaranteed, uniform, permanent corner seal. Portals Plus Corners eliminate the cutting, folding, stretching and cementing of materials into unnatural shapes. The Outside Corners have expansion radii molded into the spine to accommodate any construction irregularities. All edges on Portals Plus Corners are feathered to allow the best possible adhesion. Outside Corners are available with or without cant and are used to flash roof curbs and skylight corners. Inside Corners simplify the difficult detail of terminating

roofing materials at corners. All Portals Plus Premolded Corners have seamless molded construction and are essential to a leak-free roof. Reduce the high cost of installation and the even higher cost of repairs by using Premolded Corners. Fast, positive, watertight corner details are important for preventing costly leaks. Corners are available in EPDM or Neoprene material.

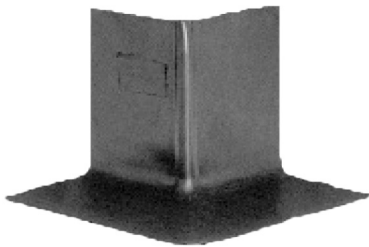

Outside Corner

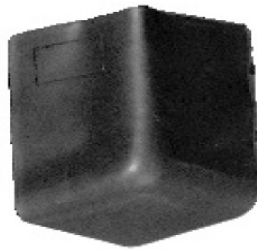

Inside Corner



Outside Corner with cant

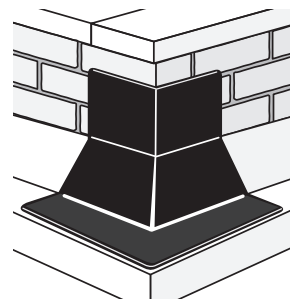
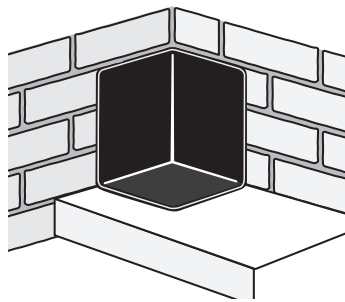
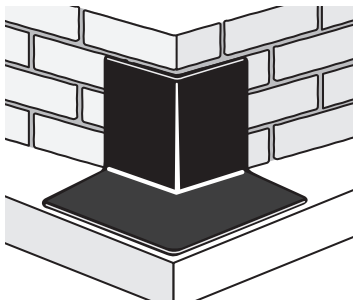



# VENTS & BREATHERS

*Relief of trapped moisture in all types of roof systems*

Portals Plus insulation Breathers and Vents are used to prevent moisture vapor from becoming trapped in the roof system. They equalize air pressure and reduce the risks of ballooning, blow-off, deteriorating insulation and separating deck seams. The Portals Plus Vents have a one-way valve designed in the unit to prevent

moisture from re-entering the roof system. The Portals Plus Breathers allow for both exhaust and convective movement of air between them. Both the Breather and Vent are available in heavy gauge spun aluminum or black, high-density polyethylene with a locking, vandal proof cap that shields against entry of wind, rain or snow.



Standard Aluminum



Plastic



Large Aluminum

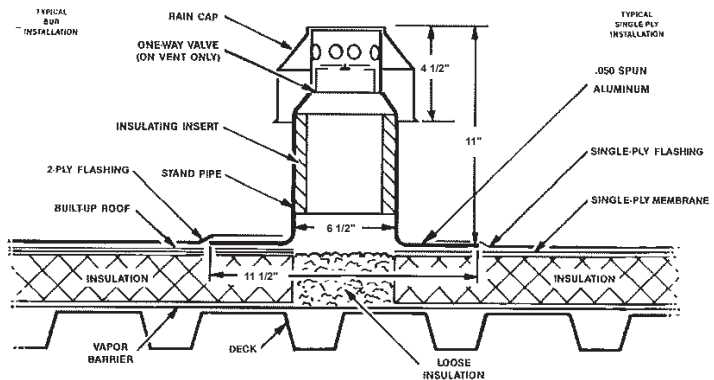
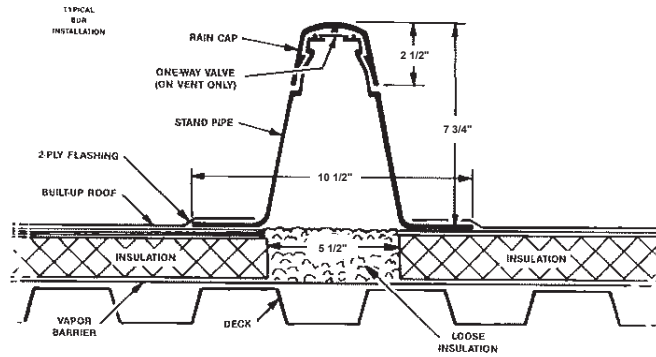
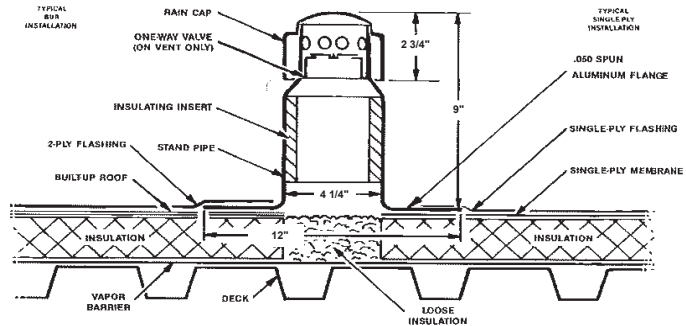

## EXPANSION JOINT COVERS

*The solution for sealing building joints*

Expansion Joint Covers are factory-manufactured, flexible, weatherproof, exterior covers for structural expansion joint openings, and are effective closures for a wide variety of special applications. Manufactured of a unique 3-ply, flexible, reinforced EPDM bellow, supported by a durable closed cell foam. This bellow allows for anticipated movement in the structure, and contains metal mounting flanges that are factory locked to each edge of the bellow. Expansion Joint Covers with reinforced EPDM bellow withstand the most extreme chemical and weather conditions without leakage. Factory-

manufactured fitting accessories (corners, tees, end terminations and crossover intersections) are designed for maximum flexibility and are produced using special techniques to ensure clean seam lines and watertight applications. Field seams are easily accomplished with standard splice kits. For use with all types of roofing, including, asphalt, coal tar bitumen, modified bitumen, EPDM, TPO, PVC, Hypalon and many others. Replaces easily torn, non-reinforced EPDM, Neoprene and easily damaged metal covers.

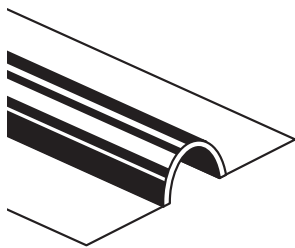

**STRAIGHT FLANGE**  
For low profile installations

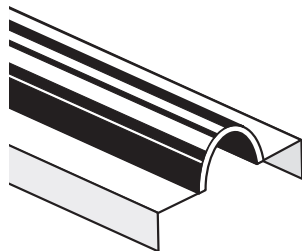

**CURB FLANGE**  
For factory manufactured curb systems or field installed wood curbs

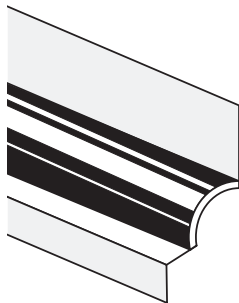

**COMBINATION CURB & STRAIGHT FLANGE**  
For factory manufactured curb systems or field installed wood curbs along walls

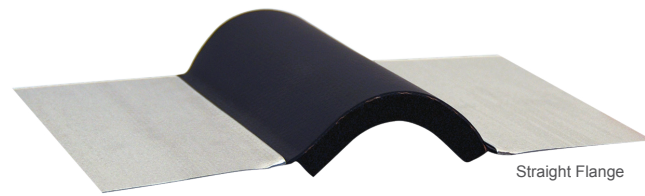

Straight Flange

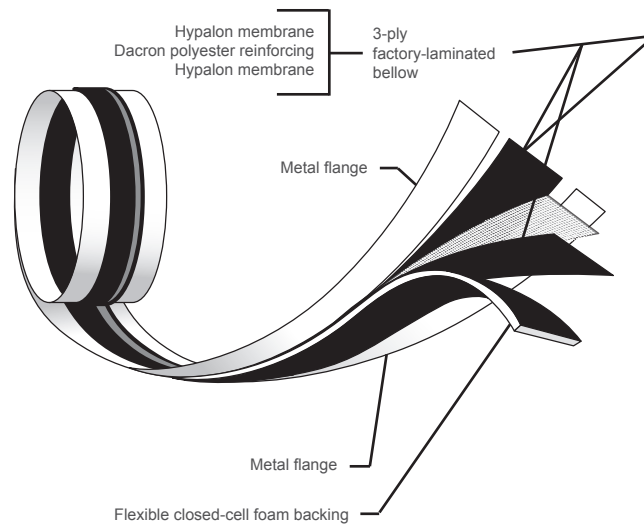

**Bellow available in the following standard widths:**  
4", 5", 6", 8", 10" and 12"

**Flanges available in the following standard materials:**  
Galvanized Steel, Aluminum, Stainless Steel and Copper

## EXPANSION JOINT COVERS

*The solution for sealing building joints*

Roof Expansion Joints are recommended to be provided for any one or more of the following minimum conditions.

- When the roof size exceeds 200 feet in any direction
- At all structural expansion or contraction joints
- Where the deck material changes, for example: from steel to concrete
- Where the deck material or structural framing changes direction
- Where building wings intersect, such as "U", "T" or "L" shapes
- Where interior heating and cooling conditions change, such as between heated and unheated
- At all building additions of any shape
- Where differential movement between walls and decks may occur

Roof Expansion Joints are recommended to be constructed with raised curb assemblies, which can allow adequate base flashing details for the roof system. Raised curb assemblies can be factory fabricated of galvanized steel to suit all project conditions, which expedites and unifies project design and installation. This is opposed to traditional wood curbs, which require extensive field installation time and thorough inspection of construction and attachment.

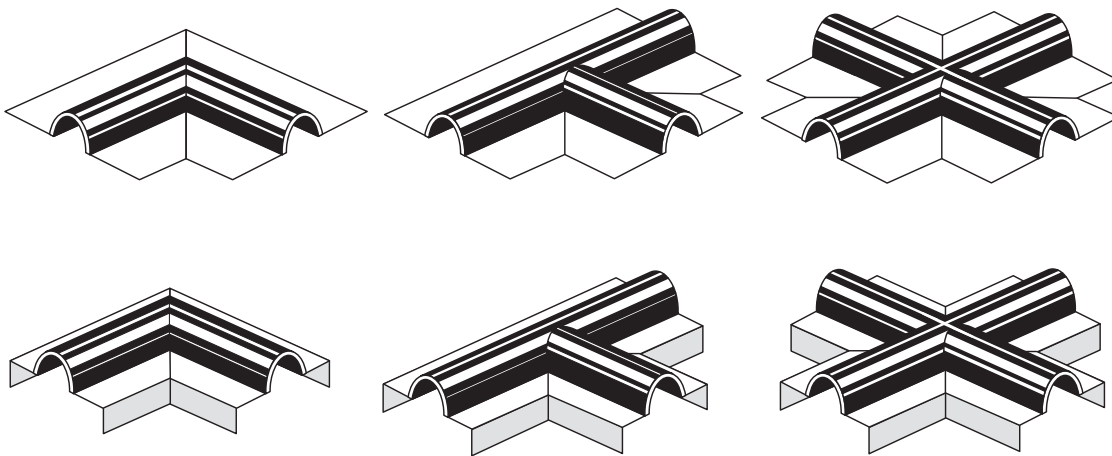

### Typical Factory Manufactured Corners and Intersections

Over the raised curb assemblies, or at low profile expansion assemblies, the Portals Plus Expansion Joint Covers provide superior watertight integrity. Along with the standard cover profiles of Curb Flange, Combination Curb & Straight Flange and Straight Flange, Portals Plus offers factory manufactured accessories available to suit virtually any project condition. The most common

accessories are Corners, Intersections and Ends. All factory manufactured accessories are custom made to suit each individual project's conditions, thereby assuring clean seam lines, continuity of joint material and watertight integrity when properly spliced with Portals Plus standard splice kits. Contact Hart & Cooley for questions regarding any special details or application.

## TAPES AND ADHESIVES

### *PlusSeal*

PlusSeal is a complete line of Tapes & Adhesives designed for single-ply roofing. The PlusSeal Adhesive products feature a three-in-one Bonding Adhesive along with other ancillary items to complete any EPDM project. The PlusSeal Tape products feature EPDM Seam Tape, Cover Strip and Flashing Tape.

#### **Solvent Based Bonding**

The PlusSeal Solvent Based Bond Adhesive is a general purpose synthetic rubber adhesive for brush or roll applications. The PlusSeal Adhesive has a long tack time and is resistant to aging, heat, cold and water. The Solvent Based bonding is a three-in-one adhesive suitable for EPDM, PVC and TPO applications. The adhesive is available in 1 and 5-gallon pails.

#### **Water Based Bonding**

The PlusSeal Water-Based Bonding adhesive is a unique synthetic bonding adhesive specially formulated to replace comparable solvent based adhesive for commercial roofing. The adhesive is designed for bonding EPDM, PVC and TPO membranes to substrates. The adhesive is available in a 5-gallon pail.

#### **Splice Adhesive**

The PlusSeal Splice adhesive is a high strength, solvent based contact cement for bonding EPDM membrane splices. Splice adhesive has a high degree of tack and excellent resistance to moisture and temperature extremes.



#### **Black Lap Sealant**

The PlusSeal Black Lap Sealant is a black polymeric sealant specifically designed for weather ability and adhesion to EPDM roofing membranes.

#### **Water Cut-Off Mastic**

The primary use of PlusSeal Water Cut-Off Mastic is as a water-block mastic in applications such as termination bars, reglets and drain clamping rings. It can also be used as a general purpose waterproofing sealant.

#### **EPDM Primer**

The PlusSeal EPDM Primer is a polymer based substrate primer. It is used to prime EPDM roofing membranes to provide adhesion to the PlusSeal EPDM Tapes and Sealants. The Primer is not to be used as a membrane cleaner

#### **EPDM Tape Products**

##### **EPDM Seam Tape**

The PlusSeal EPDM Seam Tape is an extruded, black, pressure sensitive, rubber adhesive backed tape designed to provide a high strength, watertight seam for single ply EPDM roofing membranes.

##### **EPDM Cover Strip**

The PlusSeal EPDM Cover Strip tape is designed to cover and protect membrane fasteners, membrane repairs and seam overlays in all EPDM roofing systems.

##### **EPDM Flashing Tape**

The PlusSeal EPDM Flashing tape is designed for flashing rooftop penetrations such as corners, pipes and general purpose flashings.

## STANDARD PRODUCT WARRANTY

Subject to the terms, conditions, and limitations stated below, Hart & Cooley, Inc. ("HCI") warrants that the HCI Commercial Roof Accessories ("Product") are free from manufacturing defects at the time of sale. HCI further warrants the Product will not prematurely deteriorate because of weathering for a period of ten (10) years from date of sale. This Product Warranty applies only to the Product and does not apply to labor, materials or construction details. If upon inspection by HCI the Product is found to be defective, HCI may provide a replacement Product or a substitute at its sole discretion.

### TERMS, CONDITIONS, LIMITATIONS

1. Owner shall provide HCI with written notice within thirty (30) days of the discovery of any alleged defects in the Product. Owner should send the written notice of defects to HCI, at 5030 Corporate Exchange Blvd. SE, Grand Rapids, MI 49512.
2. If upon HCI's inspection, HCI determines that the defect in the Product is caused by material deficiencies, except as provided in Paragraphs No. 3 and No. 4, Owner's remedies and HCI's liability shall be limited to HCI's replacement of the Product or its equal, at HCI's sole discretion.
3. This Warranty shall not be applicable if, upon HCI's inspection, HCI determines that any of the following has occurred:
  - (a) The Product is damaged by natural disasters, including, but not limited to, lightning, fire, hail, earthquake, tornado, hurricanes, and gales; or
  - (b) The Product is damaged by any acts of negligence, accidents or misuse, including, but not limited to, vandalism, civil disobedience, or acts of war; or
  - (c) Product not furnished by HCI is used and fails or causes defects in HCI Product; or
  - (d) Deterioration or failure of building components, including, but not limited to, the roof deck, metal roof components, walls, mortar, machinery, HVAC units, etc., occurs and causes damage; or
  - (e) Deterioration or failure of the Product caused by, including, but not limited to, harmful gases in insulations, defects or harmful substances in insulations or other underlying materials; or

- (f) Usage or spillage of material or substance not compatible with the Product, including, but not limited to, petroleum based products, oils, acids, animal fats, harmful chemicals, and the like, which come in contact with the Product and causes deterioration.
4. This Warranty shall be null and void if either of the following occurs:
    - (a) Failure by the Owner to use reasonable care in maintaining the roof system and HCI's products; or
    - (b) Owner fails to comply with all the terms or conditions stated herein.
  5. HCI shall have no obligation under this Warranty unless all the bills for the Product have been paid in full.
  6. HCI's failure at any time to enforce any of the terms or conditions stated herein shall not be construed to be a waiver of such terms or conditions.
  7. This Warranty supersedes and is in lieu of any and all other expressed warranties that are in conflict with the terms and conditions stated herein.
  8. No representative of HCI has authority to make any representations or promises except as stated herein.

THE REMEDIES STATED HEREIN ARE THE SOLE AND EXCLUSIVE REMEDIES FOR FAILURE OF THE PRODUCTS. THERE ARE NO WARRANTIES EITHER EXPRESSED OR IMPLIED, INCLUDING THE IMPLIED WARRANTIES OF FITNESS FOR A PARTICULAR PURPOSE AND MERCHANTABILITY, WHICH EXTEND BEYOND THE FACE HEREOF. HCI SHALL NOT BE LIABLE FOR ANY INCIDENTAL, CONSEQUENTIAL OR OTHER DAMAGES INCLUDING, BUT NOT LIMITED TO, LOSS OF PROFITS OR DAMAGE TO THE BUILDING OR ITS CONTENTS UNDER ANY THEORY OF LAW WHATSOEVER.











BUILD FOR THE FUTURE

Customer Service and Support:

Airmate (USA)..... 800.992.8368  
 Airmate (CAN) .....888.735.5475

Ameriflow .....800.252.8467

Amerivent (Retail) .....800.252.8467  
 Amerivent (Wholesale)..... 800.423.4270  
 Amerivent (Support).....800.748.0392

AMPCO (USA) .....800.669.3269  
 AMPCO (CAN).....888.735.5475

DuraVent ..... 800.835.4429

Hart & Cooley..... 800.433.6341  
 Hart & Cooley (Support) .....800.748.0392

Heatfab (USA).....800.772.0739  
 Heatfab (CAN) .....800.848.2149

Lima..... 800.423.4270

Milcor .....800.774.5240

Portals Plus.....800.774.5240

RPS..... 800.624.8642

Security Chimney (USA)..... 800.361.4909  
 Security Chimney (CAN) .....800.667.3387

Selkirk (USA)..... 800.848.2149  
 Selkirk (CAN) ..... 888.735.5475  
 Selkirk (Support).....800.748.0392

Manufacturing & Distribution Centers:

CANADA

Nobel, ON	Manufacturing
Laval, QC	Manufacturing
Prescott, ON	Distribution

USA

Grand Rapids, MI	Center of Excellence
Dallas, TX	Distribution
Englewood, OH	Distribution
Huntsville, AL	Manufacturing & Distribution
Mira Loma, CA	Distribution
Nampa, ID	Manufacturing & Distribution
Turner Falls, MA	Manufacturing & Distribution
Vacaville, CA	Manufacturing

MEXICO

Ojinaga, MX	Manufacturing
Mexicali, MX	Manufacturing

Corporate Headquarters:

DuraVent Group  
 28 W. Adams, Suite 1810  
 Detroit, MI 48226  
 Tel: 800.835.4429  
 Email: [info@duraventgroup.com](mailto:info@duraventgroup.com)  
[www.duraventgroup.com](http://www.duraventgroup.com)

**PORTALSPLUS**<sup>™</sup>  
BY duravent<sup>™</sup>

**duravent**<sup>™</sup>  
GROUP

BUILD FOR THE FUTURE

[www.duraventgroup.com](http://www.duraventgroup.com)

